

254T/256T TEAO/TEFC

Models

NTQPM-47-1518-4 15HP, 440-480 VAC

NTQPM-43-1518-5 15HP, 550-600 VAC

Key Features

- 30% to 50% reduction in wasted energy
- 4% to 20% reduction in energy usage
- Rapid payback – typically less than 18 months
- Exceeds NEMA Premium & IE3/IE4 efficiency standards
- Maintains high efficiency under partial load
- Superior low speed torque
- Standard NEMA frame sizes for easy substitution
- UL listed

NovaTorque, Inc.

3501 Gateway Blvd.
Fremont, CA 94538

Tel: +1 (510) 933-2700

Fax: +1 (510) 933-2763

Email: info@novatorque.com

www.novatorque.com



NovaTorque 15HP 1800 RPM PremiumPlus+® Motors

Electronically Commutated Permanent Magnet (ECPM) Motors

NovaTorque motors are Electronically Commutated Permanent Magnet (ECPM) motors, also referred to as PMAC (Permanent Magnet AC) Motors, designed for variable speed applications. Like all PM motors they are inherently more efficient than induction motors, and that efficiency advantage expands under partial load. Unlike conventional PM motors, NovaTorque's unique patented rotor and stator geometry focuses magnetic flux, allowing the use of low cost ferrite versus rare earth magnets to provide extraordinarily rapid payback on the initial investment.

**15HP Variable-Torque Application
1800 RPM Motor**

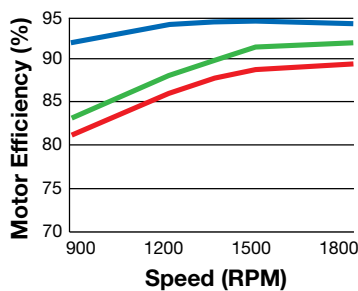

— NovaTorque PremiumPlus+®
— NEMA Premium® Induction
— Epact

**15HP Torque vs. Speed
1800 RPM Motor**

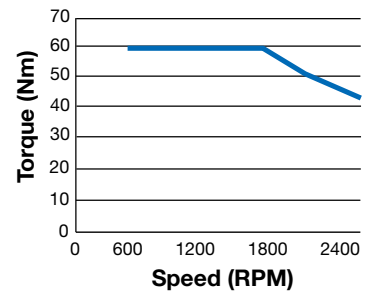

— Rated Torque

15HP 1800 RPM PremiumPlus+® Motors

Compatible Variable Frequency Drives (VFDs)

Like all permanent magnet motors, NovaTorque motors require a VFD to operate. Virtually all leading manufacturers of VFDs produce versions capable of sensorless control of PM motors. Consult NovaTorque Applications Engineering for compatible models and parameters.

Specifications

Model	NTQPM-47-1518-4	NTQPM-43-1518-5
Rated Power (HP)	15.0	15.0
Phases	3-Phase	3-Phase
Drive Supply Voltage	440-480 VAC	550-600 VAC
Rated Full Load Amps	18.4	14.8
Rated Efficiency	95.4	95.4
Rated Torque (Nm)	59.4	59.4
Rated Speed (RPM)	1800	1800
Rated Frequency (Hz)	90	90
Maximum Speed (RPM)	2400	2400
Service Factor	1.15	1.15
Frame Size	254T/256T	254T/256T
Enclosure	TEAO/TEFC	TEAO/TEFC
Weight	295 lbs	295 lbs
Maximum Winding Temperature	130 °C	130 °C
Insulation Grade	Class F	Class F
Ambient Temperature Rating	-25 to 40 °C	-25 to 40 °C
Ingress Protection	IP 44 Standard IP 54 Optional	IP 44 Standard IP 54 Optional

Dimensions

254T/256T

[in] mm

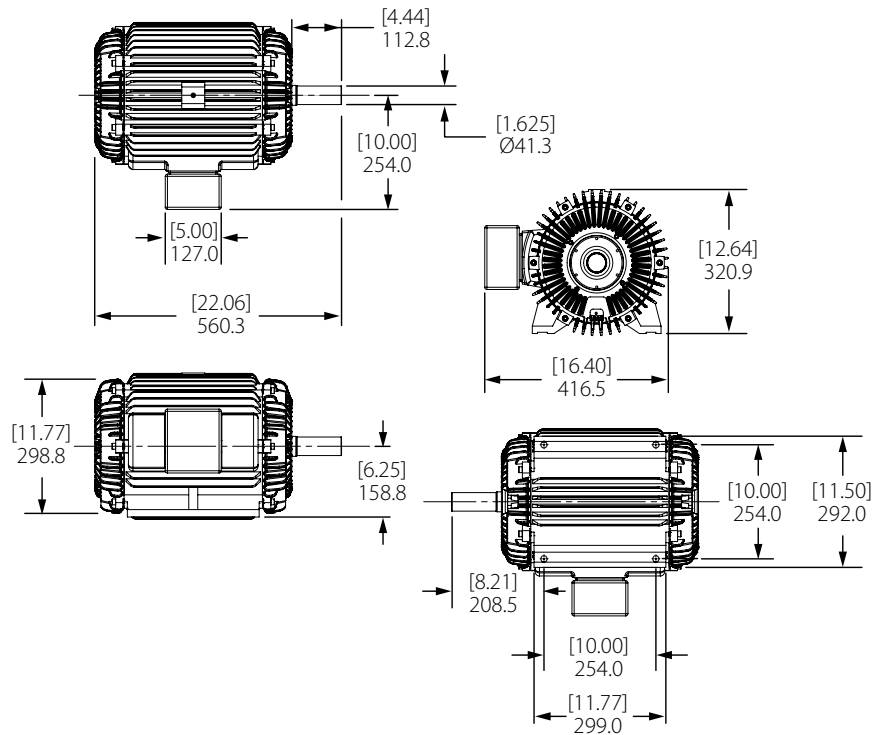

All Dimensions Nominal

For more information, visit the NovaTorque website, www.novatorque.com